



Hegewald & Peschke
Meß- und Prüftechnik GmbH

Product Information

Universal testing machine Inspekt 200kN



Hegewald & Peschke, Meß- und Prüftechnik GmbH
Am Gründchen 1, 01683 Nossen, Germany
Telephone: +49 35242 445-0, Telefax: +49 35242 445-111
E-Mail: info@hegewald-peschke.de
<http://www.hegewald-peschke.com>

Technical data:

Test load tension/ compression	200kN
Mechanical design	two-column testing machine with 2 ball-screws and bellows, AC-drive
Stiffness load frame	250kN/ mm (with deformation of load cell and adapters)
Force measurement	Grade 0.5/1 depending on type load cell (according DIN ISO 7500-1, ASTM E4)
Crosshead speed V	0.005mm/ min to 600mm/ min
Drive systems travel resolution	0.015µm
Power ratings	3P/ PE/ 400V/ 50Hz, 4.0kVA, 5-40°C, 20-80% humidity
Weight	1100kg
Controller	EDC 580

Dimensions:

	[mm]
H (Height)	2150
H test (Test area height)	1200
H max * (Max. crosshead travel)	1080
B absolut (Width with control)	ca. 1750
B (Width)	1080
B test (Test area width)	610
T (Depth)	700

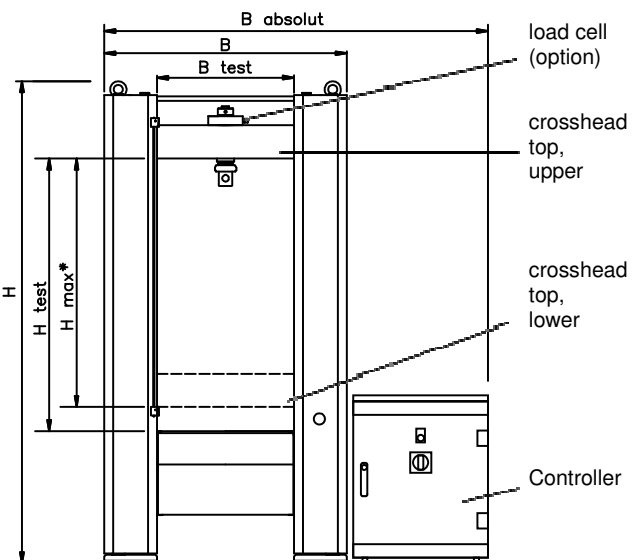

View universal testing machine with dimensions

*crosshead travel without grips, adapters and load cells

Your contact person: