

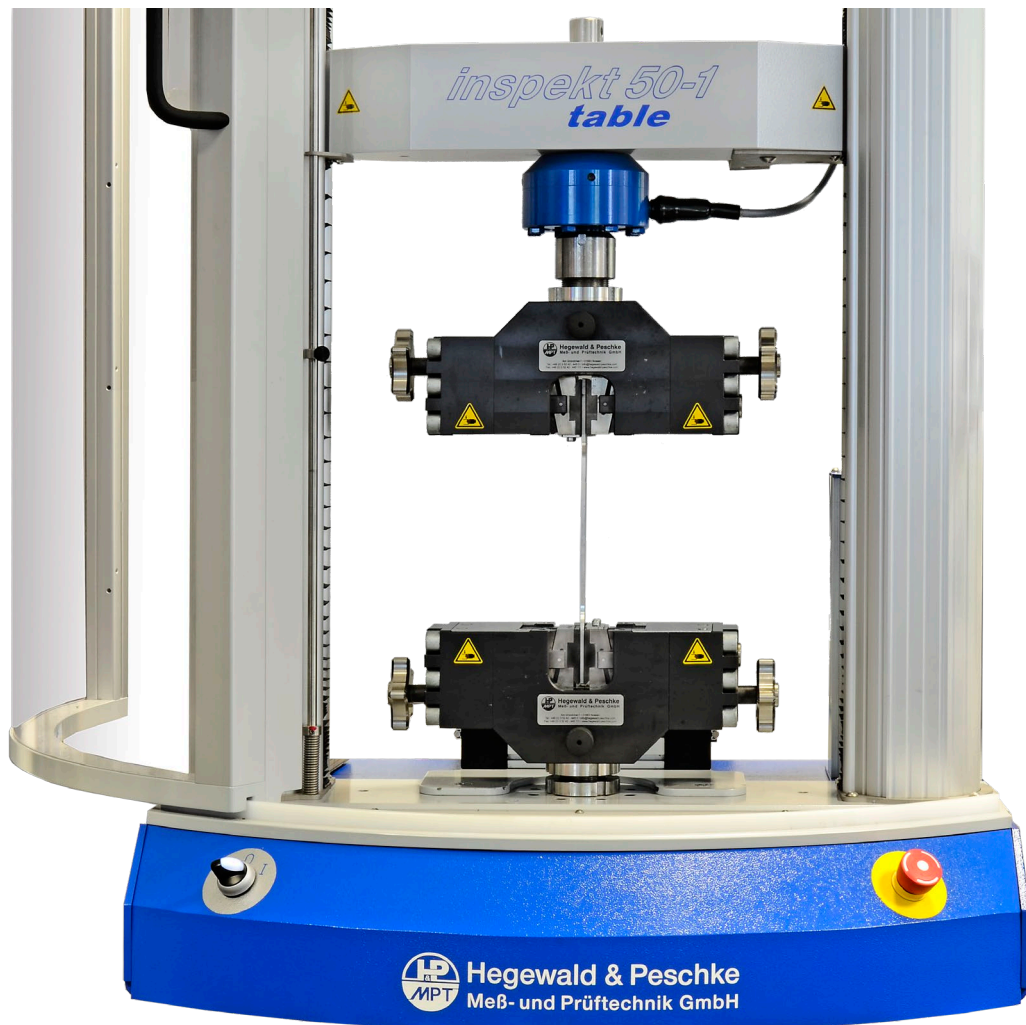

Product Information

Screw type wedge action grips

20 kN and 50 kN



Scope of Application

Screw type wedge action grips are mainly used for tensile tests. Compression and bending tests can be realized via optional connections in the base body.

Specimen Material:

- Metals, alloys
- Thermo- and thermosets as well as fiber-reinforced plastics
- Wood materials
- (Geo-) textiles

Specimen Shapes:

Round and flat specimen, e.g.

- Strip specimens
- Shoulder specimens
- Round bars
- Wires

Functionality

The opening and closing of the grips is carried out manually by actuating the hand wheels. In addition, a preload is applied thereby.

Technical Data

Due to the wedge action of the clamping jaws, the clamping force increases according to the tensile force.

Features

- Low minimum clamping length of specimen
- Easy changing of clamping jaws without tools
- Flat jaws are equipped with a specimen stopper
- Use of special jaws for special specimen dimensions possible
- Low overall height in machine frame
- Clamping ring prevents slipping of the coupling (synchronous/asynchronous clamping)
- 50kN: To simplify handling, the scale is located at the front, not at the top.
- Optionally also available with motorized drive for closing/opening
- Optionally for use at low & higher temperatures
- Optionally with torque control device (Art.-No.: 14-103-903) for applying reproducibly preclamping loads
- Optionally with handling device for textiles

	14-103-920	14-103-050
Capacity	20 kN	50 kN
Connection	R20/8-H	R36/18-H
Temperature range	-40°C up to +200°C	
Clamping force factor	1.57	
Max. symmetrical opening	flat 30 mm, round Ø 20mm	
minimum clamping length	25 mm	
Dimensions (HxWxD)	108 x 322 x 86 mm	
Weight per grip	12 kg	
Included in delivery	1 pair of wedge action grips without clamping jaw 2 pieces adapter positioning bolts 1 set of wedge base bodies KGK45 (Art.-No.: 14-103-305) for clamping jaws type insertion with sample depth stop	
	<ul style="list-style-type: none"> • Clamping of asymmetrical specimens with a gap > 4mm on request • Screw type wedge action grips with extended clamping range on request • Screw type wedge action grips for use in the temperature range from -70°C to 250°C on request 	

Your contact person:



Changing of clamping jaws by simple insertion

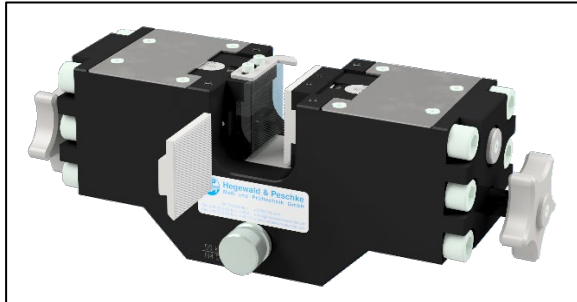

Switchable synchronization

By means of the switchable synchronization, the screw type wedge action grips can tension symmetrically and asymmetrically (for example, tests of shear specimens). The offset is easy to adjust and remains secure even when re-tightened. As a result, a one-hand operation on the left or right is also possible for asymmetric specimen, and the test area is always in the test centre.

Accessories for flexible samples (e.g. textiles): Handling device (Art.-Nr.: 14-103-902)

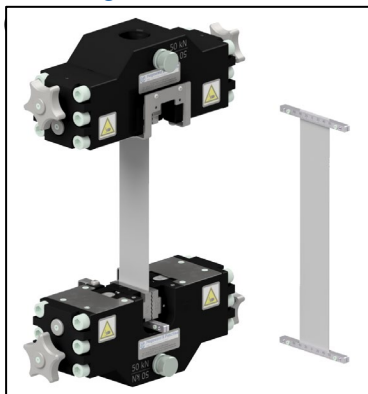

Specimen dimensions length max. 400mm, width 60mm, thickness max. 2,5mm

Included in delivery Clamping aid incl. counterweight for crease-free insertion of the specimen

The clamping aid can remain in the screw type wedge action grips during the test.



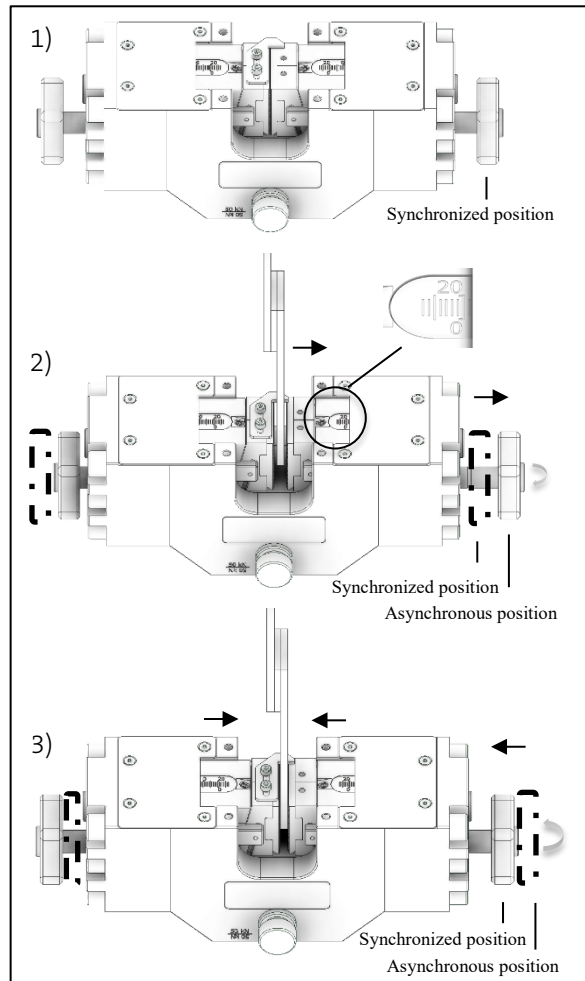



Clamping of asymmetric specimen

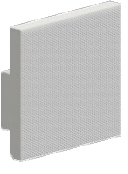
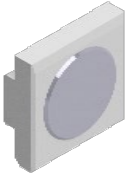

- 1) Close the grip in the synchronized position. Both clamping jaws are at zero position.
- 2) Switch to asynchronous mode and open right jaw. The opening distance is determined by the specimen and adhesive thickness.
- 3) Switch back to sync and close both jaws.
- 4) On request, the coupling shaft can also be fixed so that the clamping devices can only be operated synchronously.

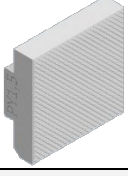
Your contact person:

Accessories: Clamping jaws for various applications

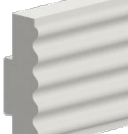
Field of application	Model	clamping area [mm]	Temperature range [°C]	Clamping range
Flat specimen and sheets:				
<ul style="list-style-type: none"> • Steel, non-ferrous metals • Wood • Plastics • Fiber-reinforced plastics • Up to R_m 1300 N/mm² 	 <ul style="list-style-type: none"> • Flat jaws with different saw tooth grids • Tool steel 56⁺² HRC • Flat jaws crosswise $\pm 30^\circ$ (shingled grid) 	WxH: 45x43 60x43	-20...+200	0...30 mm* 0...20 mm*
<ul style="list-style-type: none"> • Fragile materials • Metal foils/straps 	 <ul style="list-style-type: none"> • Flat jaws with ceramic insertion 	D=35	-15...+80	0...10mm
<ul style="list-style-type: none"> • Clamping sensitive foils • Steel sheets • Non-ferrous metals 	 <ul style="list-style-type: none"> • Flat jaws with diamond coating grain size D91 F0,2 	WxH: 45x35 60x35	-15...+80	0...30 mm* 0...20 mm*
<ul style="list-style-type: none"> • Up to R_m 1900 N/mm² 	 <ul style="list-style-type: none"> • Flat jaws with 90° pyramid toothings, optional with different profile depths/grids • Tool steel 64⁻² HRC 	WxH: 45x43	-20...+200	0...20mm
Round specimen and rods:				
<ul style="list-style-type: none"> • Steel • Up to R_m 1300 N/mm² 	 <ul style="list-style-type: none"> • Prism jaws with different saw tooth grids • Tool steel 56⁺² HRC 	L=43	-20...+200	according to Ø: d = 4-8mm d = 8-14mm d = 12-30mm
<ul style="list-style-type: none"> • Up to R_m 1900 N/mm² 	 <ul style="list-style-type: none"> • Prism jaws with 90° pyramid toothings, optional with different profile depths/grids • Tool steel 64⁻² HRC 	L=43	-20...+200	according to Ø: d = 4-8mm d = 8-14mm d = 12-30mm
Tapes and foils:				
<ul style="list-style-type: none"> • Geotextiles • Textile tapes • Plastics • Tissues 	 <ul style="list-style-type: none"> • Flat jaws with PU coating (Vulkollan®) 	WxH: 45x35 60x35	-15...+80	0...30 mm* 0...20 mm*
<ul style="list-style-type: none"> • Tissues 	 <ul style="list-style-type: none"> • Wave profile 	WxH: 45x35 60x35	-20...+200	0...30 mm* 0...20 mm*

* At the widened design of the clamping jacks, the clamping range is reduced by 20 mm

Your contact person: